



STEEL DOORS & FRAMES

 **FITZPATRICK**
PERFORMANCE METAL DOORSETS

INDEX

An introduction	P. 04
Discover the Fitzpatrick difference	P. 05
Our certifications	P. 06-07
Fitzpatrick product overview	P. 08-09
Understanding the metal doors complexities	P. 10-11
Customized door concept	P. 12
Series door concept	P. 14
Metal frames	P. 16-17
Fire & insulated doors	P. 20-21
Sound reduction doors	P. 22
Security doors	P. 24
Ballistic doors	P. 25
Blast resistant doors	P. 26
Air transfer grilles	P. 30
Vision panels	P. 31
Sublimation system	P. 34-35
Fitzpatrick in practice	P. 36-49
Introducing other products	P. 50-51





INTRODUCTION

For more than 70 years, Fitzpatrick in the UK manufactured and supplied the market with fire rated metal doors for commercial, industrial and special building applications throughout the world.

Since the year 2001, Fitzpatrick, comprised of a management team with a wealth of experience in the field, has established a manufacturing facility to produce fire resistant doors, acoustical doors, security doors, ballistic doors, fire resistant rolling shutters, and steel sliding doors. Later on, Fitzpatrick expanded its capabilities and experience to add to its products the linen chutes, garbage chutes and fire curtains that are compliant with British Standards, American Standards and European Standards.

Offering design, manufacture and installation services with an ISO 9001, ISO 14001 and OHSAS 18001 certified manufacturing plant, Fitzpatrick uses modern manufacturing techniques and adopts high quality standards for production planning in a way to have the flexibility to execute projects of all types and sizes.

A continuous product development and an exhaustive performance testing program are enabling Fitzpatrick to offer a wide range of certified door assemblies. Over the years, Fitzpatrick has developed many innovative product ranges for specific market sectors including banks, high rise buildings, educational facilities, health care and leisure projects.

Fitzpatrick products are among the most reliable steel doors manufactured using high quality material and the most advanced techniques. the company is using the latest technology and equipment to ensure the highest quality and customer satisfaction.

Fitzpatrick installation service includes on-site survey, measurements, installation, follow up and maintenance. this helps maintaining quality from manufacture to testing & commissioning and ensures that the installed products are identical to what have been certified and tested by third parties.

Fitzpatrick is a DHI (door & hardware institute) corporate member.





Fitzpatrick Fire doors installed at Beirut City Center

DISCOVER THE FITZPATRICK DIFFERENCE

Support

The specifications, design, manufacture and installation of metal doorsets (especially fire rated), represent a complex technical process that should be flawless in order to get the desired output.

Fitzpatrick offers assistance to specifiers and architects (when required) to ensure that products meet expectations. Expert technical support is provided by a team of experienced engineers and the project management service is optimized to suit every project's size providing the smoothest and the most effective project execution.

Fitzpatrick installation service helps maintaining quality during the whole process and ensures that the installed products are identical to what have been certified and tested by third parties.

Quality, Safety & Environmental

Fitzpatrick management team is engaged to provide high quality products and services, to always meet the needs and requirements of the customers and to seek continuous improvement through a Total Quality (TQM) framework.

The QSE management system was developed, elaborated, and is continuously improved by Fitzpatrick team in accordance with ISO 9001:2015 quality management system, ISO 14001:2015 environmental management system and ISO 45001:2018 occupational health & safety management.

Fitzpatrick management is committed to pollution reduction and continuous improvement of environment security; Therefore, a full commitment through the company to the implementation of the QSE management system, its improvement and effectiveness is a core to the company's values.

Fitzpatrick operates a strict health and safety policy and has recently achieved the ISO 45001:2018 standard.



Certified by Afnor UK



OUR CERTIFICATIONS

All our doorsets and frames are fully certified to recognized performance standards. The company is certified to ISO 9001, ISO 14001 & ISO 45001:2018.

Our Fire Resisting doorsets are tested and or certified to the British Standard BS 476 part 22 by Warrington Exova Certifire and Intertek for up to 4 hours.

Moreover, it is tested and or certified to the European Standard EN1634-1 for both Integrity and Insulation by Efectis, Intertek and Certifire. As for the American Standard, our doors are tested and or certified to UL 10C and NFPA 80 by Underwriters Laboratories UL and Intertek.

Our sound reduction doors are rated as follow:

- STC30 till STC51 by IFT Rosenheim.
- STC39 and STC45 by PKA acoustic consulting.
- STC39, STC40, STC41, STC42, STC45 and STC46 by Intertek.
- STC44 by SRL sound research lab.

Sound Transmission Class (or STC) is an integer rating of how well a door attenuates airborne sound.

Our Ballistic Doors are rated FB4 & FB6 to the EN1522 by UKAS.

Each of the other products such as rolling shutters, sliding doors or chutes are rated to one or more standards and by one or more third parties.



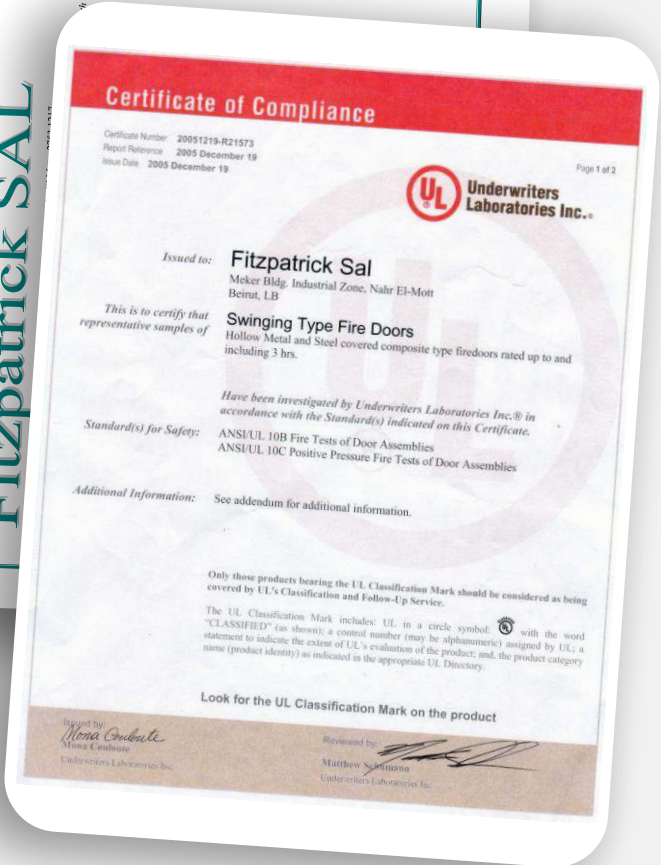



Fitzpatrick Acoustic doors installed at **Cinemacity** (Beirut Souks)

FITZPATRICK PRODUCT OVERVIEW

Fitzpatrick high quality metal doors, fire rated doors, security doors and sound reduction doors have evolved over three decades of research to suit most commercial and industrial applications.

All doorsets are designed and manufactured using sophisticated computerized equipment to be accurate, robust and low maintenance.

The physical properties of steel; durability, flexibility, strength and high fire-resistance offer significant security and performance advantages over other material.

Fitzpatrick offer many product ranges each delivering different performance characteristics as well as a steel frame option, all of which are available either primed for on-site painting, or powder coated to any available RAL color.

Metal Doorsets

The Fitzpatrick range of standard metal doors has been designed to be suitable for any application that does not require any formal certification. As with all Fitzpatrick products the Metal Door can be adapted to meet specific requirements.

Fire Rated Metal Doorsets

The Fitzpatrick range of fire rated metal doors has been specifically designed to meet the requirements for prolonged fire resistance for periods of up to 240 minutes and according to many standards such as BS476:22, EN1634-1 & UL10C.

Sound Reduction Metal Doorsets

The Fitzpatrick sound reduction metal doors have been developed using mineral wool to meet specific acoustic performance requirements. Certain products within the acoustic doors range also offer fire resistance.



Fitzpatrick Acoustic doors installed at [Cinemacity \(Beirut Souks\)](#)

Security Metal Doorsets

The Fitzpatrick range of security doorsets have been designed to offer protection against various levels of attack from petty burglars using small tools, up to attempted, forced entry with high powered machinery. Fitzpatrick security doorsets have an ideal specification for residential properties and they can be wood cladded.

Metal Frames

The Fitzpatrick metal frames can be manufactured in galvanized steel or stainless steel and they can be customized to receive any wooden leaf.

The Fitzpatrick range of metal doorsets provides a highly adaptable solution to the needs of many sectors. The quality service and flexible personal approach taken by Fitzpatrick team ensures the range can satisfy the performance and aesthetic requirements of many sectors including education, health, industry, commercial and leisure for both interior and exterior locations.

All doorsets can be manufactured to specific opening sizes, allowing differences in size, configuration and construction to be accommodated. All Fitzpatrick doorsets can be manufactured in stainless or galvanized steel and finished in primer or powder coated to any available RAL color. As size, configuration, door construction and performance are all inter-related, it is advantageous for the client to discuss specific requirements with the design team in the early stages of a project.

UNDERSTANDING THE METAL DOORS COMPLEXITIES

Metal Frame

Can be manufactured from 1.5mm or 2mm galvanized or stainless steel sheet and it can be delivered in knock down or corner welded type, and in many frame types or shapes.

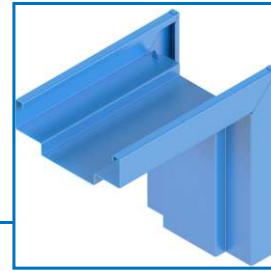
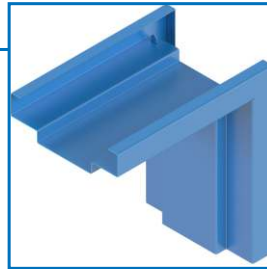

1

Metal Leaf

Can be manufactured from 1.2mm or 1.5mm galvanized or stainless steel sheet.

2

Lock

Fitzpatrick metal door can be manufactured to accommodate any type of locks according to architectural hardware set specifications.

3

Opening Direction

Fitzpatrick Doors are handed according to the below chart.

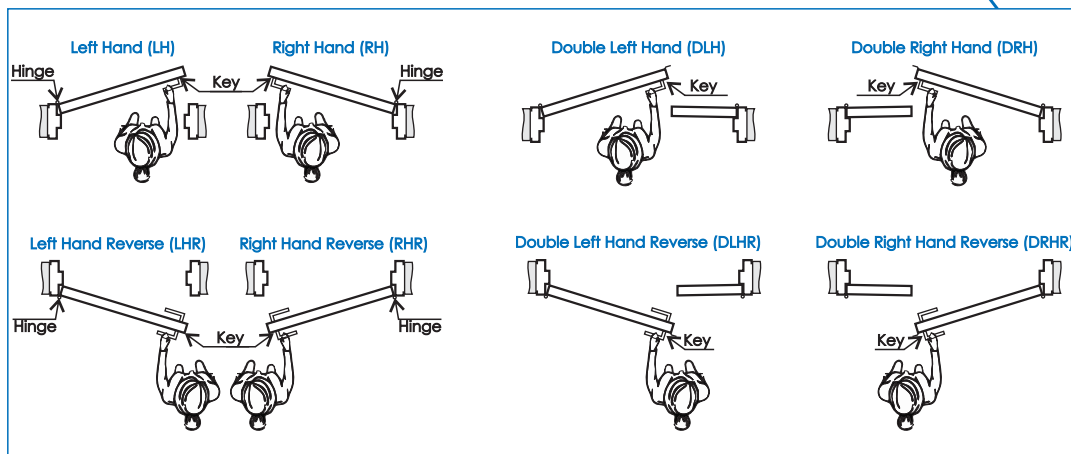

4

Door Closer

Generally doors come prepared to receive a standard overhead door closer; Metal doors can also be prepared for a concealed door closer if requested by hardware descriptions.

5

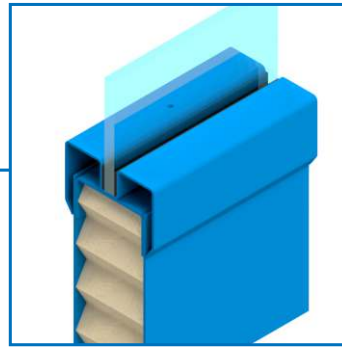

Vision Panel

Fitzpatrick metal doors can be fitted with vision panels of different shapes and sizes. Attached detail is for a typical glazing system.

6

Hinges

Fitzpatrick metal doors can be manufactured to receive many types of hinges (such as ball bearing or concealed hinges), according to architectural hardware set specifications.

7

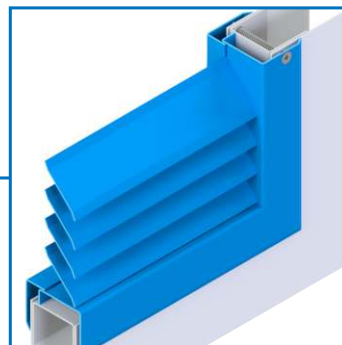

Louvers

Air transfer grilles or louvers can be fitted in both internal and external doorsets for ventilation and either can be fire rated or non-fire rated. Attached is the detail of a typical non-fire louver.

8

9

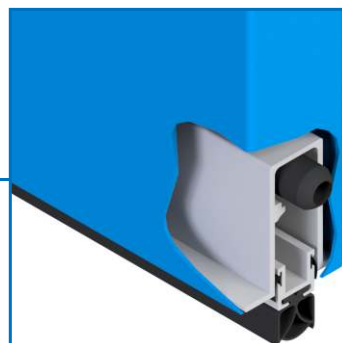

Drop Seal

All metal doors can be prepared for the drop seal if requested by client or by the norms such as in acoustic doors.



Fitzpatrick double egress doors installed at all entrances of **ABC Verdun**

FITZPATRICK CUSTOMIZED DOOR CONCEPT

Open up to a new way to buy a door, Think outside the frame and create your own customized door to fit your unique style, while you can rely on our engineers to guide you in order to respect the international standards such as Fire Rating, Sound Reduction, Insulation or Security.

Determine Your Door Size

You can size up your custom door with any dimensions.

Material

You can choose to manufacture your door from many different metal sheets such as galvanized G90, Stainless 304 Brushed, Stainless 316 Brushed or Stainless with mirror shine finish.

Frame Type

You can use this catalogue to choose from many suggested frame types or you can work on your own design working with our design team..

Ironmongery

You can choose any type or brand of ironmongery and we will customize the door to receive them without any preparation on site.

Vision and Louver

you can design your door with any shape, dimension or size or louver.

Complete the Details

Finally, it's the finishing touches that make all the difference, therefore, you can paint your door with any available RAL color or you can dress it with a unique wood finish design to make your hollow metal door look like a work of art.

Any Size. Any Material. Any Ironmongery. Any Design.... Imagine the possibilities



Fitzpatrick hidden access panels installed at [Sama Beirut](#)



Fitzpatrick fire rated doors installed at service areas of **ABC Verdun**

FITZPATRICK SERIES DOOR CONCEPT

If you are looking for the Fitzpatrick high quality fire doors with a competitive price and fast production, then the Series Door Concept is what you are looking for. Fitzpatrick Series are a wide range of standard doors with specific dimensions, hardware and colors.

Material and Colors

Frame: 1.5 mm Galvanized Metal Sheet / Leaf: 1.25 mm Galvanized Metal Sheet
Frames and Leaves can be painted to RAL 1013, 7040 or 9010 with a peel texture.

Frame Type

Standard single rebate G type frame with 150 mm width is used for all types of Series.

Astragal

All double doors are equipped with double astragal for more security.

Fire Rating

All doors are fire rated to BS476:22 and to EN1634-1

Details

Series #	Door Type	Lock Type	Vision Panel	Range of Dimensions (mm)			Fire Rating
				Height	Width	Step	
SSFGK-HPC44	Single	Sashlock	N/A	2000 - 2400	800 - 1100	50	240 min
ESFGK-HPC44	Double	Sashlock	N/A	2000 - 2400	1500 - 1850	50	240 min
USFGK-HPC44	Double Unequal	Sashlock	N/A	2000 - 2400	1200 - 1600	50	240 min
SPFGK-HPC44	Single	Panic Bar	N/A	2000 - 2400	800 - 1100	50	240 min
EPFGK-HPC44	Double	Panic Bar	N/A	2000 - 2400	1500 - 1850	50	240 min
UPFGK-HPC44	Double Unequal	Panic Bar	N/A	2000 - 2400	1200 - 1600	50	240 min
SSVGK-HPC44	Single	Sashlock	400 x 400	2000 - 2400	800 - 1100	50	60 min
ESVGK-HPC44	Double	Sashlock	400 x 400	2000 - 2400	1500 - 1850	50	60 min
USVGK-HPC44	Double Unequal	Sashlock	400 x 400	2000 - 2400	1200 - 1600	50	60 min
SPVGK-HPC44	Single	Panic Bar	400 x 400	2000 - 2400	800 - 1100	50	60 min
EPVGK-HPC44	Double	Panic Bar	400 x 400	2000 - 2400	1500 - 1850	50	60 min
UPVGK-HPC44	Double Unequal	Panic Bar	400 x 400	2000 - 2400	1200 - 1600	50	60 min

Doors with vision panel can have higher rating upon request



غرفة
كهرباء
Electrical
Room

Fitzpatrick fire rated doors installed at Beirut City Center

FITZPATRICK METAL FRAMES

Fitzpatrick metal doorframes can be manufactured in stainless steel or galvanized steel. They are available in either a primed or powder coated finish to any available RAL color and can be manufactured in many sizes and many configurations as follows:

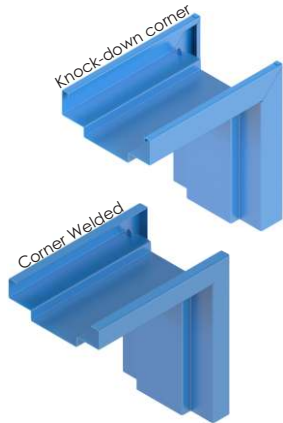

- Single or double rebated matching the overall width of the wall.
- Corner type can be KD or corner welded type, variously as may be required by specifications.
- It can be "Flush" or "Wrap-Around".
- 1.5 mm or 2 mm steel sheet thickness.
- Our metal frames are delivered with textured powder coating, to agreed colors selected from RAL ranges.
- Various seals may be installed if required by specifications.

A full range of fixing options is available. Doorframes are prepared to receive Fitzpatrick's standard hinges although a range of alternative hinges is available to suit special applications.

Frames are manufactured to accommodate special ironmongery and preparations such as overhead closer, security bolts, panic furniture, lock strikes, flush bolts and indicator bolts.

For ease of transport and handling, frames are normally supplied in "knock-down" form to be later erected on site. This is particularly beneficial for large projects and for economic delivery worldwide.

Frame Fixing



Expansion Anchor
Typical for concrete masonry units (CMU's). can be used on any type of wall With or without concrete filling



" T " A n c h o r
Typical for Masonry and concrete wall Concrete filling is a must

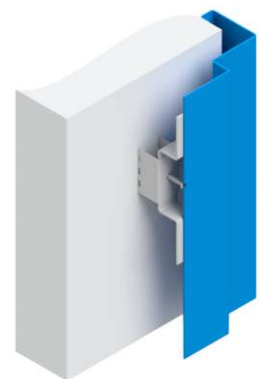

Compression Anchor
Typical for Gypsum Can be used on any type of wall Wrap-Around frame is a must

(Other frame fixing are available upon request)

A wide range of frame profiles are available to suit for various applications for either traditional or new methods of construction. The illustrations below show the most commonly used frame profiles.

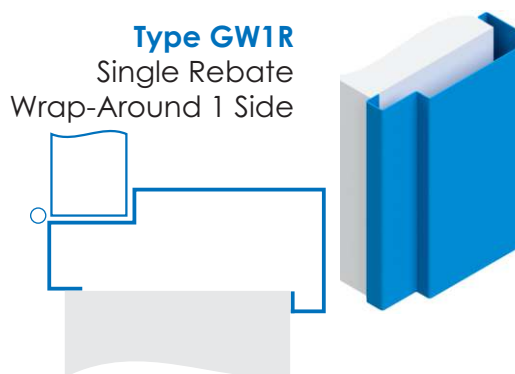
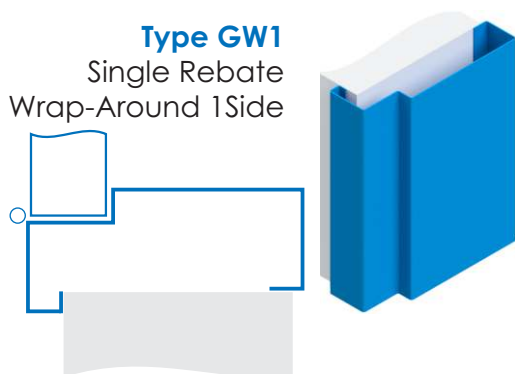
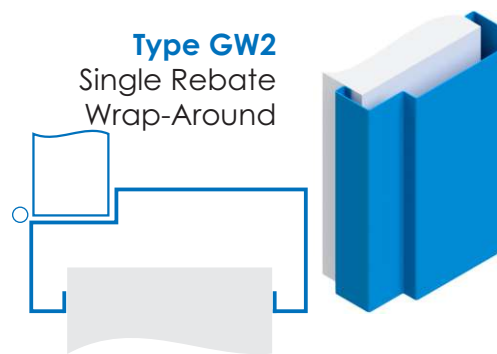
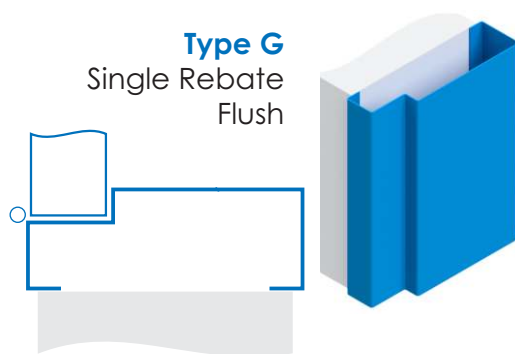
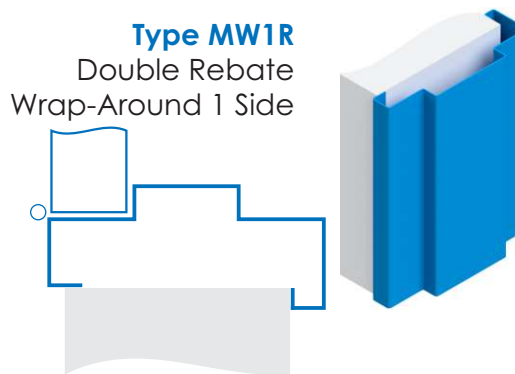
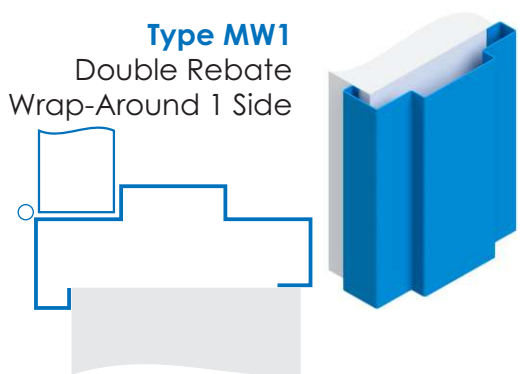
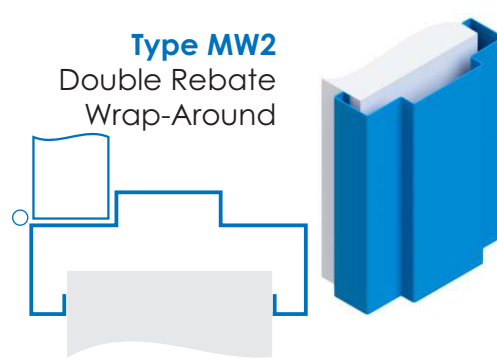
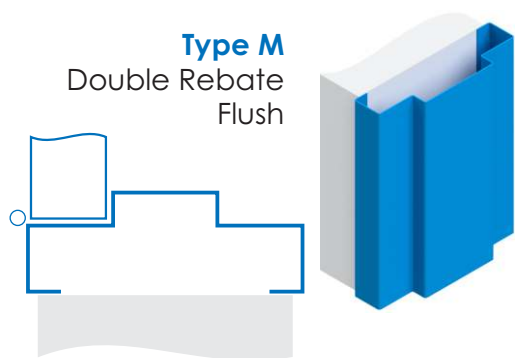

(Double egress frame, Double action frame and other profiles are available upon request)





**Armenian
Community
College, Beirut**

FITZPATRICK FIRE (INTEGRITY & INSULATED) DOORS

General Information

Integrity doors are used to protect property and life in the event of a fire by inhibiting the spread of fire, whereas insulated doors are used when it is required to retard the transmission of heat from one area to another.

Fitzpatrick metal doors can be manufactured in stainless steel or galvanized steel, frames are manufactured from 1.5mm sheet thickness while leaves are manufactured from 1.2 mm sheet thickness.

They are available in either a primed or powder coated finish to any available RAL color and can be manufactured in many sizes and many configurations to suit the architectural design of the protected area.

A big range of RAL colors is available upon the client's request and in many textural finishes such as "Orange Peel", "Sandy", "Bright" or "Matt".

Fitzpatrick metal doors can also attain a wood-like finish by using the latest Italian Sublimation technologies. For more details refer to sublimation section in this catalog.



Extended Fire Resistance Doors and Insulated Doors

Fitzpatrick range of integrity and insulated doors has been specifically designed to meet the requirements for prolonged fire resistance for periods of up to 240 minutes in integrity and 180 minutes in insulation, and to be as flexible as possible to meet all the specifier's aesthetic/architectural requirements. The inherent properties of steel fire doors eliminate the need for intumescent seals as the metal expands with heat to seal any gaps.

Fire Resistance

Fitzpatrick fire doors have been successfully subjected to BS476: Part 22 and UL 10C fire testing allowing Fitzpatrick to certificate 60, 90, 120, 240 minute assemblies to the British standard or European Norm and 45, 1-1/2, 3 hours to the American standard.

Fire rated doors are manufactured strictly in accordance with the IFC scheme or the Intertek scheme or the UL scheme and they are available in a Honeycomb or Rockwool core as a standard infill material.

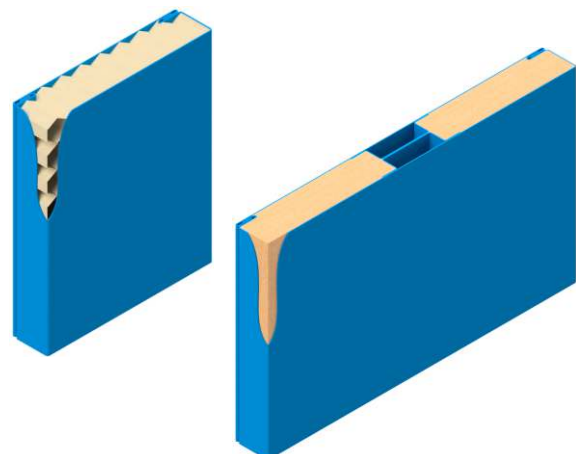

Insulated doors

Fitzpatrick range of insulated doors have been successfully tested to EN 1634-1:2014 at  efectis group insulating Doorsets allowing Fitzpatrick to certificate 30, 60, 120 and 180 minute insulation.

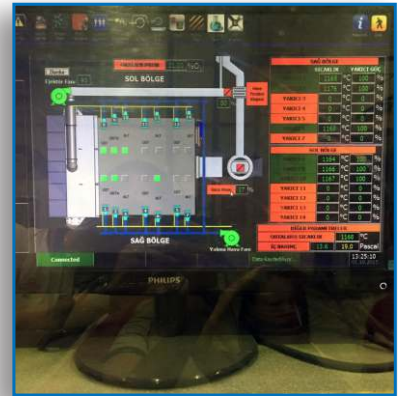

Ironmongery

Fitzpatrick fire doors are prepared to receive any type of ironmongery according to the hardware set description.

In addition, all our metal doors are reinforced with 5mm reinforcements to receive the required hinges and 3mm reinforcements to receive locks and strikes.

Vision Panels & Louvers

All fire rated doors can receive a glazed vision panel or a fire louver, sizes can vary depending on the fire-rating norm, duration and client's requirements.

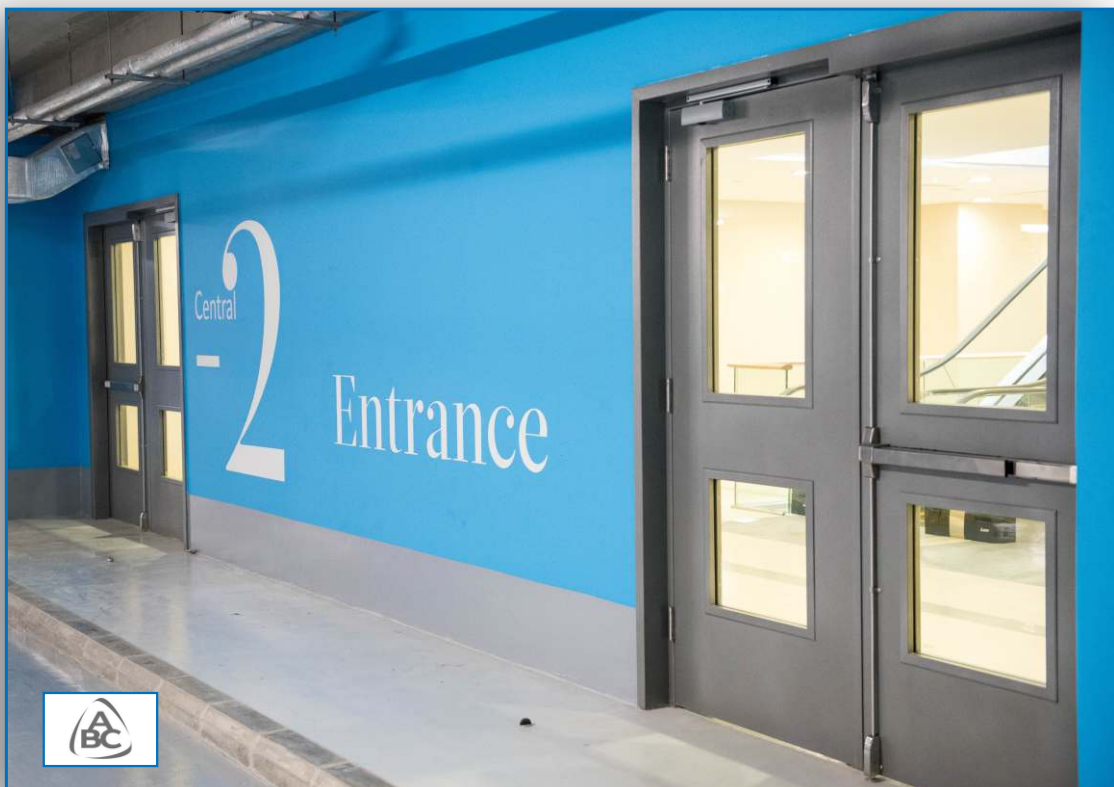

FITZPATRICK SOUND REDUCTION DOORS

General Information

Fitzpatrick's sound reduction metal doors have been developed using mineral wool to meet specific acoustic performance requirements. Certain products within the acoustic doors range also offer fire resistance.

Fitzpatrick sound reduction doors can be manufactured in stainless steel or galvanized steel, frames are manufactured from 1.5mm or 2mm sheet thickness depending on the acoustic performance, while leaves are manufactured from 1.2 mm or 1.5 sheet thickness.

They are available in either a primed or powder coated finish to any available RAL color and can be manufactured in many sizes and many configurations to suit the architectural design of the protected area.



Performance

The effects of acoustic privacy and nuisance noise are subjective and influenced by background noise, distance from sound source and general context, amongst others. When considering walls containing doors, it is the combined performance of both elements that is relevant, clearly the proportion of door to wall area is particularly important.

Fitzpatrick offers a total engineered metal doorset solution that provides very effective sound reduction for areas with high noise levels, such as plant or generator rooms. With complete engineered doorsets, all components are factory-assembled to the closest tolerances and thoroughly tested to ensure that required performance levels are successfully achieved.

Preparation, installation and best practice on-site are also crucial elements in the process to stop sound leakage.

Acoustics is a complex field of a wide variety of performance levels.

It should be remembered that performance values quoted for products and ranges are based on laboratory test results; on-site testing will generally produce lower results.

Testing

Fitzpatrick sound reduction doors have been successfully tested at Intertek and SRL laboratories to achieve the STC39, STC40, STC41, STC42, STC43, STC44, STC45 sound reduction performance.





15A

Fitzpatrick fire rated exit door installed at Sama Beirut

FITZPATRICK SECURITY ENTRANCE DOORS

General Information

Fitzpatrick's high security steel doors offer a wide range of protection and performance characteristics.

Fitzpatrick's security doors include the security by design doors for residential applications.

Security doors must offer resistance to threats from petty burglars using small tools up to attempted forced entry with high powered machinery.

Fitzpatrick security doors are available in either primed or powder coated finish to any available RAL color and can be wood clad to suit the architectural design of the protected area.

Fitzpatrick security doors are available in five distinct levels of security protection:



Fitzpatrick Level 1

Resistance to attack with hand tools, small levers, pliers, spanners, etc or bodily force. These are usually relatively noiseless attempts to gain entry by opportunists.

Fitzpatrick Level 2

Resistance to attack with heavier hand tools, pipe wrench, claw hammer or hand drill where the burglar is more determined and is not afraid of creating some noise.

Fitzpatrick Level 3

Resistance to attack with more substantial and heavier tools such as a crowbar, a small cordless power drill, an axe or blowtorch. At this level the threat is made by a determined criminal who is not too concerned about the noise he makes in his attempt to gain entry.

Fitzpatrick Level 4

At this level the threat is made by a determined professional who uses tools such as heavy sledgehammers, power drilling, cutting and grinding equipment.

Fitzpatrick RC3

Subject Doors are tested and certified by IFT Rosenheim to EN1627 - En1630. These doors are equipped with Electrified multipoint locking devices and do not come with the Wood Cladding Option.

FITZPATRICK BALLISTIC DOORS & WINDOWS

General Information

Where security is becoming an ever more important aspect of building design, Fitzpatrick Ballistic doors are ideal for applications where the risk of armed attack may be of a serious consideration.

Installations such as police stations, shooting ranges, banks and embassies would benefit from the extra assurance provided by this excellent doorset.

Fitzpatrick ballistic doors, are available in either a primed or powder coated finish to any available RAL color and can be manufacture in many sizes and many configurations to suit the architectural design of the protected area.

A big range of RAL colors is available upon your request and in many textural finishes such as "Orange Peel", "Sandy", Fitzpatrick metal doors can also attain a wood-like finish by using the latest Italian Sublimation technologies, for more details refer to sublimation section in this catalog. "Bright" or "Matt".



FB& BR Classifications

Fitzpatrick can offer a wide range of Ballistic Doors, Ballistic Glazed Doors and Ballistic windows tested to FB4 & BR4, FB6 & BR6 Classifications by DGA laboratories in England (accredited by UKAS), in accordance with the requirements and procedures set out within "BS EN 1522:1999 Windows, Doors, Shutters and Blinds - Bullet Resistance - Requirements and Classification" & "BS EN 1063:2000 Glass in building - Security Glazing - Testing and Classification of Resistance against Bullet Attack".

Tested With:

Various weapon types, bullets & velocities according to the below table:

Class	Weapon type	BULLET			Test conditions		
		Caliber	Shape	Structure	Weight (g)	Shooting dist. (m)	Velocity (m/s)
FB1	Rifle	22 LR	Round nose	• lead	2.6	10	360
FB2	Automatic pistol	9 mm Luger	Round nose	• full steel jacket • soft core (lead)	8	5	400
FB3	Hand gun	357 Magnum	Coned bullet	• full steel jacket • soft core (lead)	10.2	5	430
FB4	Hand gun	44 Rem. Magnum	flat nose	• full steel jacket • soft core (lead)	15.6	5	440
*AK47	Kalachnikov	7.62 x 39	pointed	• full steel jacket • soft core (lead) (nk: 2)	8	10	700
FB5	Assault rifle	5.56 x 45	pointed	• copper jacket • steel core • steel penetrator	4	10	950
FB6	Rifle	7.62 x 51	pointed	• full metal jacket • soft core (lead)	9.5	10	830
FB7	Rifle	7.62 x 51	pointed	• copper jacket • steel hard core	9.8	10	820

FITZPATRICK BLAST RESISTANT DOORS

General Information

An explosion is a sudden release of gas at high pressure in the environment. Sudden, because the release must be sufficiently rapid for the energy contained in the gas dissipated via a shock wave.

Blast protection is one of today's biggest challenges. Fitzpatrick will have to hand. A Petro-chemical blast may be regarded as different to that of a terrorist blast attack but fundamentally, blast doors and windows will have to perform the same task - protection people, places and possessions.



Standards and Requirements

Open range: DIN EN 13123-2 & 13124-2
Shock tube: DIN EN 13123-1 & 13124-1

Requirements of the petro-chemical industry according to ASCE

Open range: extract from DIN EN 13123-2 / 13124-2		
Facade, windows, door, shutters	mass (kg TNT)	distance (m)
EXR 1	3	5,0
EXR 2	3	3,0
EXR 3	12	5,5
EXR 4	12	4,0
EXR 5	20	4,0

Shock tube: extract from DIN EN 13123-1 / 13124-1		
Facade, windows, door, shutters	peak pressure (bar) ¹⁾	positive specific impulse (I+) (bar-ms)
EPR 1	0,50	3,7
EPR 2	1,00	9,0
EPR 3	1,50	15,0
EPR 4	2,00	22,0

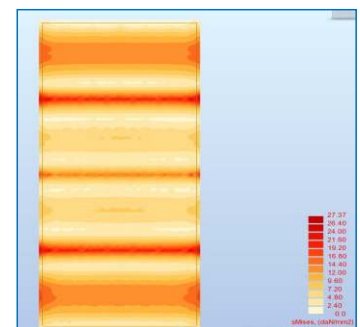

Blast Resistant Doors

Fitzpatrick blast resistant doors are manufactured to meet the international requirements of blast pressure based on design calculations and certified by an approved third party consultancy offices in accordance with industry standards.

Fitzpatrick's blast doors are manufactured from steel, with an inner welded framework connected to front and rear doors skins with multiple welds. The voids between reinforcing members are entirely filled with Rockwool infill.

All construction details, reinforcement, and frame anchoring, depend solely on the calculation design of the specified blast pressure.

Fire Rating

Fitzpatrick blast doors are up to 3 hours fire rated to UL10C.

Paint

Fitzpatrick blast doors can be polyester powder coated from a standard range of RAL colors or factory applied epoxy prime base coat.

FITZPATRICK PRISON DOORS

General Information

Detention doors can be used for several applications such as penitentiaries, police stations, airports, courthouses. They are available in two distinct levels of security protection, maximum and minimum.

Fitzpatrick prison doors, are available in either a primed or powder coated finish to any available RAL color and can be manufactured in many sizes and many configurations to suit the architectural design of the detention area.

Doors are internally reinforced and mounted with a detention security lock and security hinges with non-removable pins.

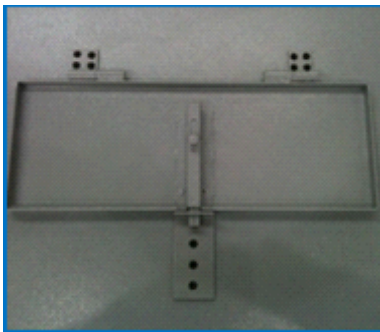

Doors can be equipped with a highly secured vision panel and food port assembly.

All exposed screws are tamperproof button head type.

Doors cannot be breached by prisoners.

Notes

All steel works are produced, fabricated and assembled **in accordance with NSSS**.

Welding is **in accordance with AWS D1.1 "STRUCTURAL WELDING CODE"**.

All sharp edges and burrs are removed.

The door sill is **electrogalvanized** after fabrication to prevent corrosion

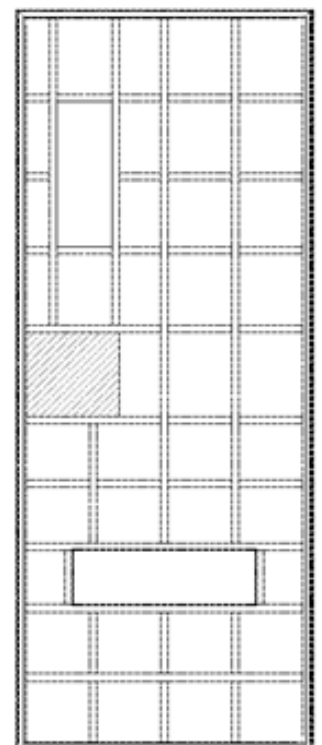



FIRE RATED
DOOR





FITZPATRICK AIR TRANSFER GRILLES

General Information

Air transfer grilles or louvers can be fitted in both internal and external doors for ventilation purposes and either can be fire rated or non fire rated (all are non-acoustic and non-insulated).

Non-Fire rated louver

Fitzpatrick non-fire rated louvers are manufactured from 1.5 mm galvanized sheets, in many dimensions according to client requirements.

A non-fire rated louver can be installed on a door leaf or as fixed panel, in addition, a full louvered steel door is also available at Fitzpatrick.

Below is the detail of a typical non-fire rated louver:

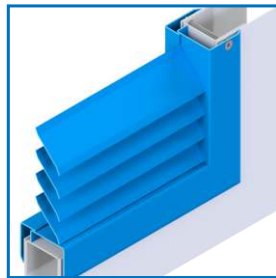

Fire rated louver

Fire rated louvers are used for passive fire protection in fire rated doors for up to 90 minutes fire protection.

Our fire rated louvers have a specific dimensions:

Type 1: 30 x 30 cm, Type 2: 45 x 45 cm, Type 3: 60 x 60 cm, Type 4: 30 x 60 cm, Type 5: 45 x 60 cm, Type 6: 30 x 45 cm.

Below is the detail of a typical fire rated louver:

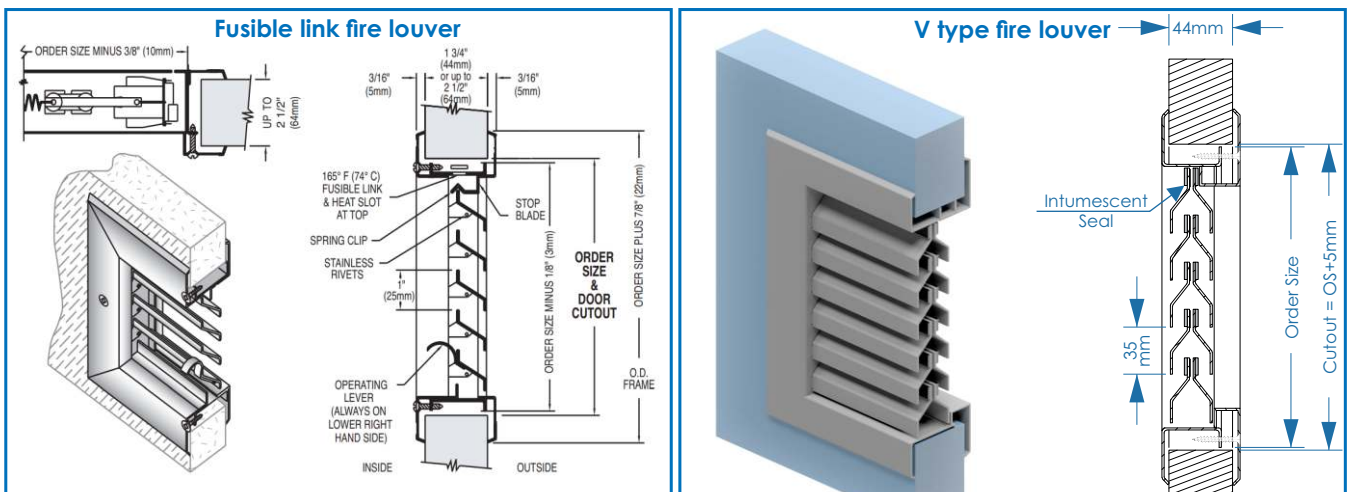

FITZPATRICK VISION PANELS

General Information

Glazed vision panels are often used to let light into a room or for safety (allowing people using the door to be seen). Below is the typical detail of a fire rated vision panel.

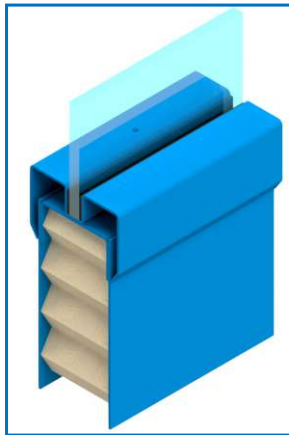

Vision styles

The most popular vision panels styles are shown below, although other designs can be accommodated. All aperture dimensions shown are clear vision sizes. A selection of glazing systems is available to suit styles as shown.

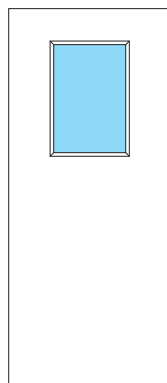

VP1

Standard size:
60 cm x 40 cm

Elevation:
160 cm to the center

Fire Rating:
120 minutes to BS
1-1/2 hours to UL

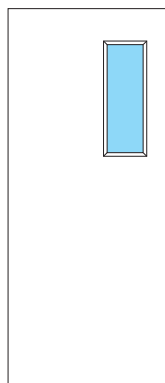

VP2

Standard size:
60 cm x 20 cm

Elevation:
160 cm to the center

Location:
15 cm from the edge

Fire Rating:
120 minutes to BS
1-1/2 hours to UL

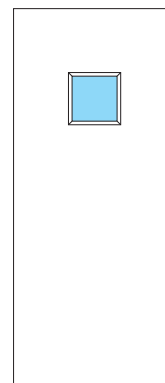

VP3

Standard size:
25 cm x 25 cm

Elevation:
160 cm to the center

Fire Rating:
120 minutes to BS
3 hours to UL

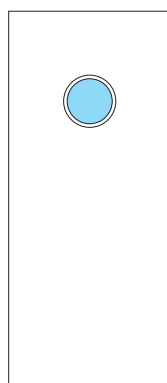

VP4

Standard Diameter:
25 cm & 40 cm

Elevation:
160 cm to the center

Fire Rating:
120 minutes to BS
3 hours to UL (25 cm)

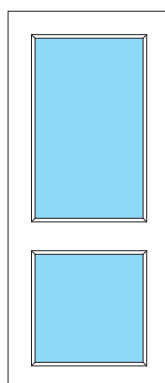

VP5

Standard size:
100 cm x 60 cm
60 cm x 60 cm

Location:
20 cm from the edges

Fire Rating:
not rated to BS
1-1/2 hours to UL

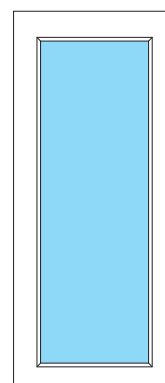

VP6

Standard size:
full vision

Location:
15 cm from the edges

Fire Rating:
not fire rated





FITZPATRICK SUBLIMATION SYSTEM

General Information

All over the world, from architects to builders and manufacturers, the incredible advantages of decorative powder coating and wood grain machine technology are being discovered.

Our sophisticated wood grain process involves utilizing a sublimation machine to apply a decorative finish on doors and frames surfaces.

Fitzpatrick decorative powder coating is enhanced by aesthetic appeal, durability and fire retardant advantages.

Fitzpatrick can accurately supply material to resemble authentic marble, deco wood grain and stone powder coat finishes, resulting in any decorative motif.

Fitzpatrick decorative powder coating technology offers the preferred choice for designers and architects, providing long-lived protection, in addition to other benefits.

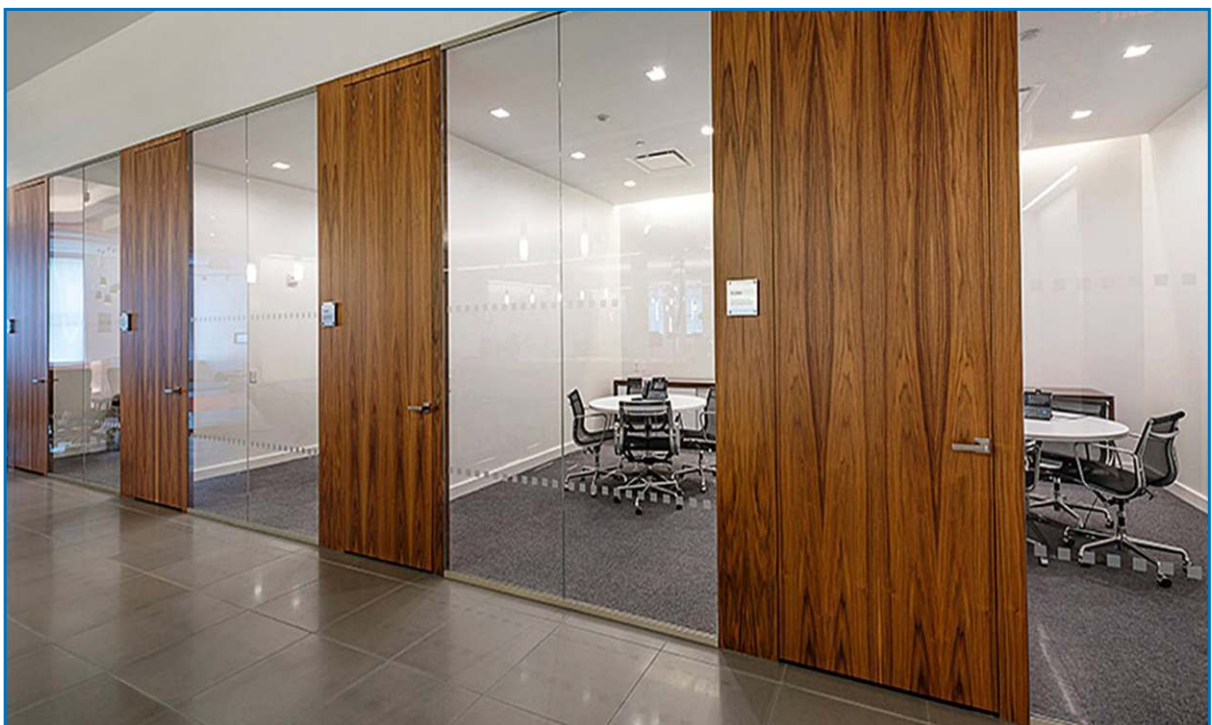
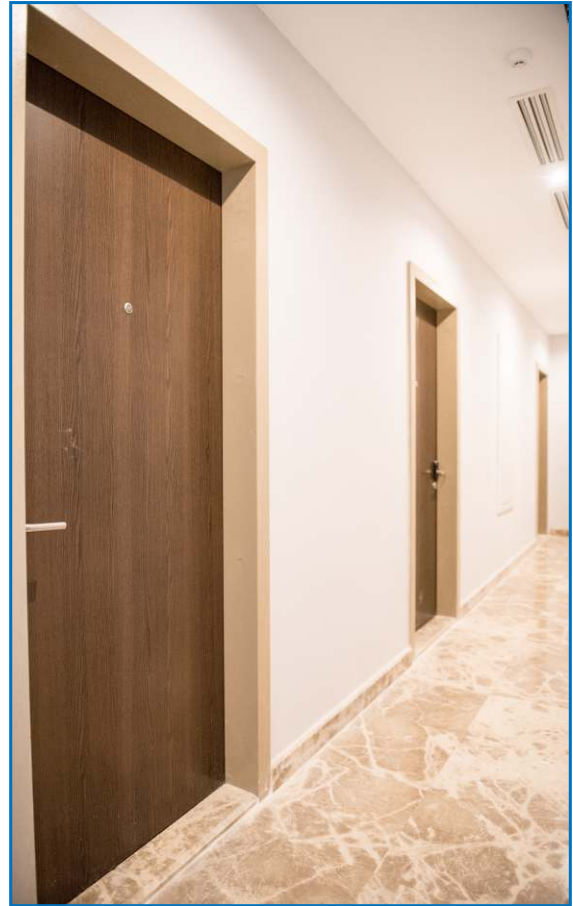

Samples of the available wood effect sublimation



DS733 + 2507-18-L



DS475 + 2501-12



8G-148-A009 + 2507-18-L



8G-148-A009 + 2501-12L



DS708 + 2507-07



DS726 + 2507-07



DS726 + 2507-18

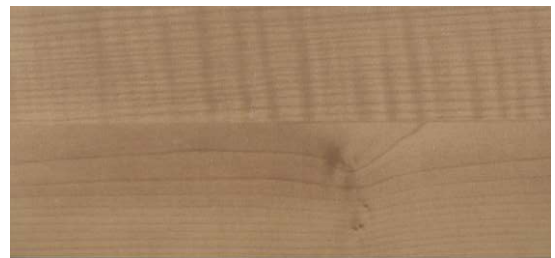

DS708 + 1101-02



DS726 + 2501-12



DS475 + 1836-01



8G-148-A009 + 1101-02



DS708 + 2507-18

This Catalog doesn't reflect the exact color of the sublimation effect, ask for physical samples from Fitzpatrick sal

FITZPATRICK IN PRACTICE



Our Global Reach

Our excellence in steel door manufacturing knows no bounds. We proudly extend our reach to countless corners of the globe. Our expertise and dedication transcend borders.

At Fitzpatrick, we understand the importance of not just being present, but being present with purpose. With an extensive portfolio spanning across diverse cultures and climates, our doors have stood the test of time, offering unparalleled protection and peace of mind to our valued clients worldwide.

As you have explored our catalogue, envision the possibilities that our doors can bring to your project. Join the countless satisfied clients who have entrusted their needs to us.

From the USA and the Cayman Islands to Bangladesh and Myanmar, **projects of different sizes, types and complexities spanning across more than 35 different countries have used Fitzpatrick doorset expertise.**

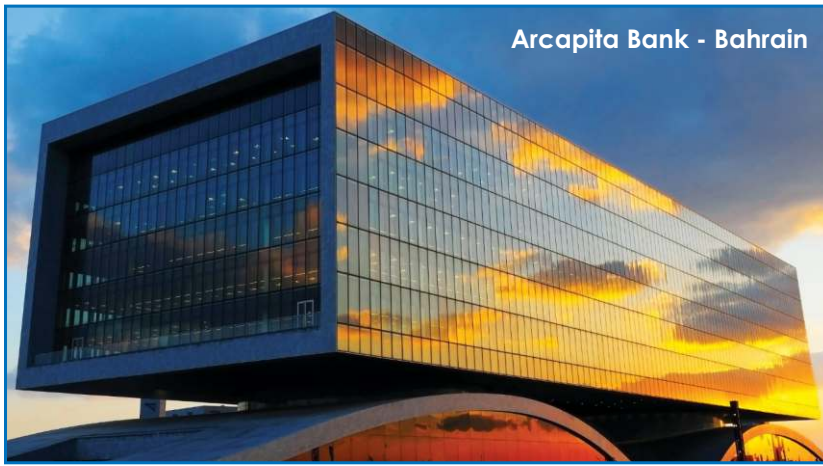

Projects of different types have used Fitzpatrick's versatile doorset expertise.





1250 fire rated & main entrance doors installed at **ABC Verdun Mall** were supplied by Fitzpatrick

LEBANON



Project name:
American University of Beirut

Location
Beirut

Year of execution:
2012-2017

Supplies:
2300 doors, frames and access panels

Project name:
Saint George Hospital

Location
Beirut

Year of execution:
2012 - 2024

Supplies:
1567 doors, frames and access panels





1413 fire rated doors installed at **Sama Beirut** were supplied by Fitzpatrick

Project name:
Abdelwahab 618 residential towers

Location
Beirut

Year of execution:
2016 - 2018

Supplies:
850 insulated doors



Project name:
Kempinski Hotel

Location
Beirut

Year of execution:
2011

Supplies:
583 steel frames and 552 fire and non-fire rated doors

Project name:
Waterfront

Location
Dbayeh - Lebanon

Year of execution:
2018 - 2019

Supplies:
1807 fire rated doors & access panels





1600 fire rated doors & wood-cladded doors installed at [Abu Dhabi Presidential Palace](#) were supplied by Fitzpatrick

UNITED ARAB EMIRATES

Project name:
Louvre Museum

Location
Abu Dhabi

Year of execution:
2014 - 2021

Supplies:
731 fire rated metal doors & stainless steel doors



Project name:
Abu Dhabi International Shooting Club

Location
UAE

Year of execution:
2016

Supplies:
1060 fire rated access panels

Project name:
Abu Dhabi Financial Center

Location
UAE

Year of execution:
2010

Supplies:
1258 fire rated metal doors





1307 fire rated metal doors installed at **Viva Bahria Towers Doha** are supplied by Fitzpatrick

QATAR

Project name:
Al Erkyah City

Location
Qatar

Year of execution:
2018

Supplies:
1313 fire rated doors



Project name:
Hamad International Airport - Doha

Location
Qatar

Year of execution:
2007 - 2012

Supplies:
510 doors and frames including security doors

Project name:
The Pearl

Location
Qatar

Year of execution:
2009 - 2011

Supplies:
926 fire rated doors & access panels





1526 stainless steel frames installed at **Dallah Hospital - Riyadh** are supplied by Fitzpatrick

SAUDI ARABIA

Project name:
Centro Hotel

Location
KSA

Year of execution:
2015

Supplies:
363 fire rated doors



Project name:
KAFCO Metro Station

Location
KSA

Year of execution:
2019

Supplies:
429 fire rated doors

Project name:
Empire Hail & Arar

Location
KSA

Year of execution:
2021

Supplies:
102 acoustic doors





2082 metal frame installed at [Kuwait National Petroleum Corporation KNPC](#) are supplied by Fitzpatrick

KUWAIT



Project name:
National Bank of Kuwait

Location
Kuwait

Year of execution:
2016 - 2017

Supplies:
2000 fire rated doors

Project name:
Kuwait University

Location
Kuwait

Year of execution:
2017 - 2023

Supplies:
4723 fire rated doors & access panels





2235 frames, doors and rolling shutters installed at **Clemenceau Medical Center Amman** are supplied by Fitzpatrick

JORDAN

Project name:
Al Seraj Hotel

Location
Jordan

Year of execution:
2014 - 2016

Supplies:
716 fire rated doors and access panels



Project name:
Al-Salt Hospital

Location
Jordan

Year of execution:
2016-2017

Supplies:
302 fire rated doors

Project name:
Kempinski Hotel

Location
Aqaba Jordan

Year of execution:
2008

Supplies:
1000 fire rated and non-fire rated doors





2660 fire rated doors installed at [Queen Alexandra Hospital - UK](#) are supplied by Fitzpatrick

EUROPE

Project name:
AUB Cyprus Campus

Location
Cyprus

Year of execution:
2024

Supplies:
152 doors



Project name:
Amara Hotel

Location
Limasol

Year of execution:
2019

Supplies:
185 doors

Project name:
Olympic Equestrian Center

Location
Greece

Year of execution:
2001

Supplies:
172 doors





119 frames installed at **AC Hotel by Marriott Kingston - Jamaica** are supplied by Fitzpatrick

AMERICA

Project name:
Otonomus Hotel - Las Vegas

Location
USA

Year of execution:
2023-2024

Supplies:
171 frames & fire rated doors



Project name:
One

Location
Cayman Island

Year of execution:
2023-2024

Supplies:
320 frames & fire rated doors

Project name:
Six Senses La Sageesse Grenada

Location
Caribbeans

Year of execution:
2022-2023

Supplies:
273 fire rated doors





2521 fire rated metal doors installed at **EKO Pearl Towers - Nigeria** are supplied by Fitzpatrick

NIGERIA

Project name:
Trinity & Azuri Peninsula Towers

Location
Nigeria

Year of execution:
2019-2024

Supplies:
1874 fire rated doors



Project name:
Famfa Oil Offices

Location
Nigeria

Year of execution:
2020-2022

Supplies:
159 fire rated doors

Project name:
Rack Data Center

Location
Nigeria

Year of execution:
2023

Supplies:
195 fire rated doors and access panels





325 fire rated metal doors installed at **Teryan 5 Residences & Courtyard by Marriott** are supplied by Fitzpatrick



Our exclusive representative in Armenia

Leon A. Yacoubian Contracting LLC

2/2 Melik Adamyas Street 0010 Yerevan, Armenia

Tel.: +374-60-722230 / Mob.: +374-93-495575 / info@layc.am

ARMENIA



AYB School Building C



AGBU Headquarters



Combined-Cycle Power Plant at Yerevan



OTHERS



Supreme Educational Council - Qatar



Sheikh Khalifa Hospital - Morocco



CIT - Ivory Coast Terminal



Garoua Hospital - Cameroon



Watkins Glazed Stainless Steel Decoration at MTV Studio Vision

INTRODUCING OTHER FITZPATRICK PRODUCTS

Glazed Stainless Steel by Watkins

Due to the growing market needs, the Glazed stainless Steel department was launched in 2007 complementing the metal works division. This new division specializes in metal and glazing works for the architectural and decorative domains.

The high quality of our work speaks for itself. From grandiose exterior facades to the most intricate interior details, we promise to deliver high quality service and finishing products.

Our products range across the following categories:

- Cladding of Columns, canopies, skylights, and other general architectural products.
- Access and railing products, including handrails, balustrades, partitions and gates.
- Structural steel such as walkways, skylight, canopies, staircases and glass parapets.
- Custom-made products, including furniture, desks, and a wide range of architectural and decorative fittings designed and manufactured to client specifications.

Fire Rated Chute Type (Linen or garbage) system

Fitzpatrick Chutes has been specifically designed to meet the requirement of fire resistance for period of up to 90 minutes according to UL 10B standard.



Metal Lockers

Fitzpatrick metal lockers are made from 1.25 mm galvanized steel sheets, they are available with either a primed or powder coated finish to any available RAL color and can be manufacture in many sizes and many configurations to suit the architectural design.



Fire rated roller shutter

The Fitzpatrick fire rated roller shutter has been independently tested to BS 476-22, this covers all relevant criteria for fire performance. The independent testing laboratories have size limitations on their test furnaces and accordingly, a full range of assessments are available as standard for shutters up to 7 meters in height and width. Clients can be confident that Fitzpatrick fire products satisfy all necessary conditions and approvals. Certification on project assessments is available for larger shutters and projects.

Rapid door

Rapid doors or high speed doors are an effective way of reducing the sound of noisy plant and guard machinery, saving energy consumption in heated or air conditioned buildings and dividing areas in manufacturing facilities in order to prevent cross contamination.

With its lateral opening technology, its opening speed of up to 5 m/s and its closing speed of up to 2.5 m/s represents the reliable solution for a fast and safe passage traffic.

The high speed doors smooth fast action, counter balanced system, strong durable door panel and full width vision panel make them ideal for industrial environments.





Ain Saadeh industrial city - Beirut - Lebanon - PO. BOX 90-1101
Tel.: +961 1 901888 - Fax: +961 1 901333
email: enquiries@fitzpatrickmetaldors.co.uk - www.fitzpatrickmetaldors.co.uk